

URSA UK LTD
Crest House
102-104 Church Road
Teddington, Middlesex TW11 8PY
United Kingdom

Tel : 020 8977 96 97
Fax : 020 8977 94 56

Web : www.ursa-uk.co.uk
E-mail : ursauk@ursa.com

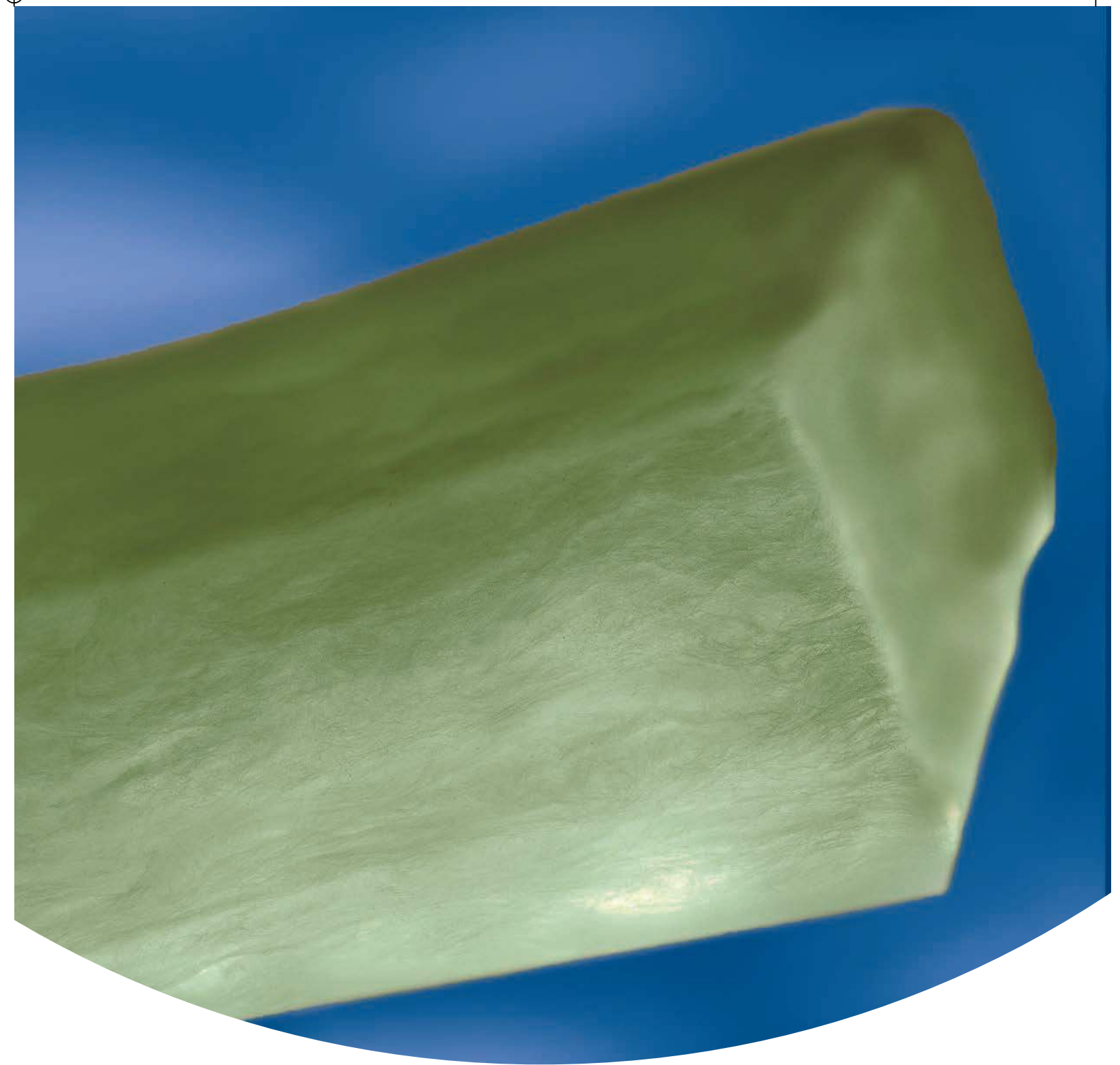

URSA MINERAL WOOL
URSA Acoustic Roll

Acoustic Insulation for Floors and Walls



The Company

As a leading supplier of insulation and insulating systems, **URSA** has succeeded in fully addressing user requirements for thermal and acoustic insulation. Quality products for every application and excellent customer support are the cornerstones of the corporate culture.

URSA is the number two manufacturer of glass wool and extruded polystyrene products in Europe. At 13 production sites, **URSA** has 2,000 employees generating sales revenues of over €500 million.

URSA mineral wool is manufactured in Spain, France and Belgium, at two sites **URSA** has in Germany, in Slovenia, Hungary and Poland as well as in two Russian plants. Our closely-woven network of sales offices stretches across Europe and Russia. Almost everywhere **URSA** is amongst the market leaders.

In Russia and in a number of other Eastern European countries, we are number one in the glasswool segment. We have also enjoyed a strong position particularly on the growth markets of the new EU partner countries from the very beginning.

URSA Acoustic Roll

URSA Acoustic Roll is a lightweight, non-combustible, unfaced glass mineral wool product for use as an acoustic insulation in timber or metal framed internal partition walls, timber or metal framed separating walls and timber separating floors.

URSA Acoustic Roll – either 1200mm wide or split into 2 x 600mm wide rolls.

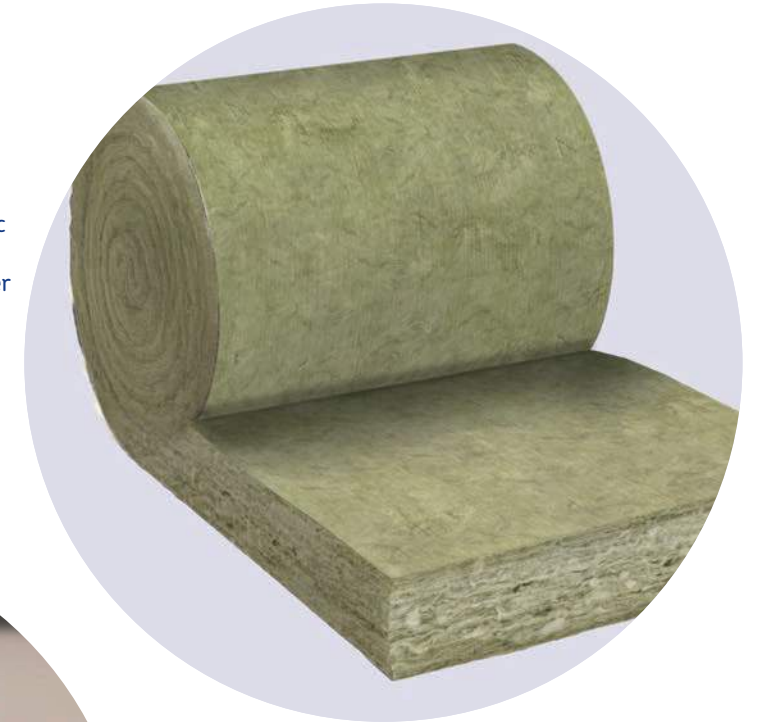

User friendly

Our new generation **URSA TERRA** mineral wool has a 'soft touch' feel making it easier to handle and install whilst still maintaining its excellent mechanical properties.

Thermal performance

URSA Acoustic Roll also has good thermal insulation characteristics and enhances the thermal comfort of the building.

Environment

URSA mineral wool is manufactured from an abundant, sustainable resource and utilises at least 50% glass waste.

Handling

URSA Acoustic Roll is lightweight yet tough, resilient and easy to install. It is easily cut using a sharp knife.

Space saving

Compaction of the rolls in their manufacture saves space in both storage and transport.

Durability

URSA Acoustic Roll is rot-proof, durable and maintenance free. It is non-hygroscopic and will not slump in normal use.

All of our products carry the CE Mark to show compliance with the harmonised European Standard BS EN 13162 and are quality assured to ISO 9001.



Benefits

Quality

Outstanding product quality manufactured to ISO 9001 Quality Systems.

Global warming potential

URSA Acoustic Roll does not use chemical blowing agents and so the Global Warming Potential (GWP) arising from it is zero.

Cost effective

Suitable for use in a variety of timber and metal frame details **URSA Acoustic Roll** is a cost effective way of insulating both new and existing buildings.

Insulation savings

URSA Acoustic Roll has excellent sound insulation characteristics to help meet the Building Regulation and Robust Details requirements.

- Headquarters
- Branch
- Production site mineral wool
- Production site extruded polystyrene

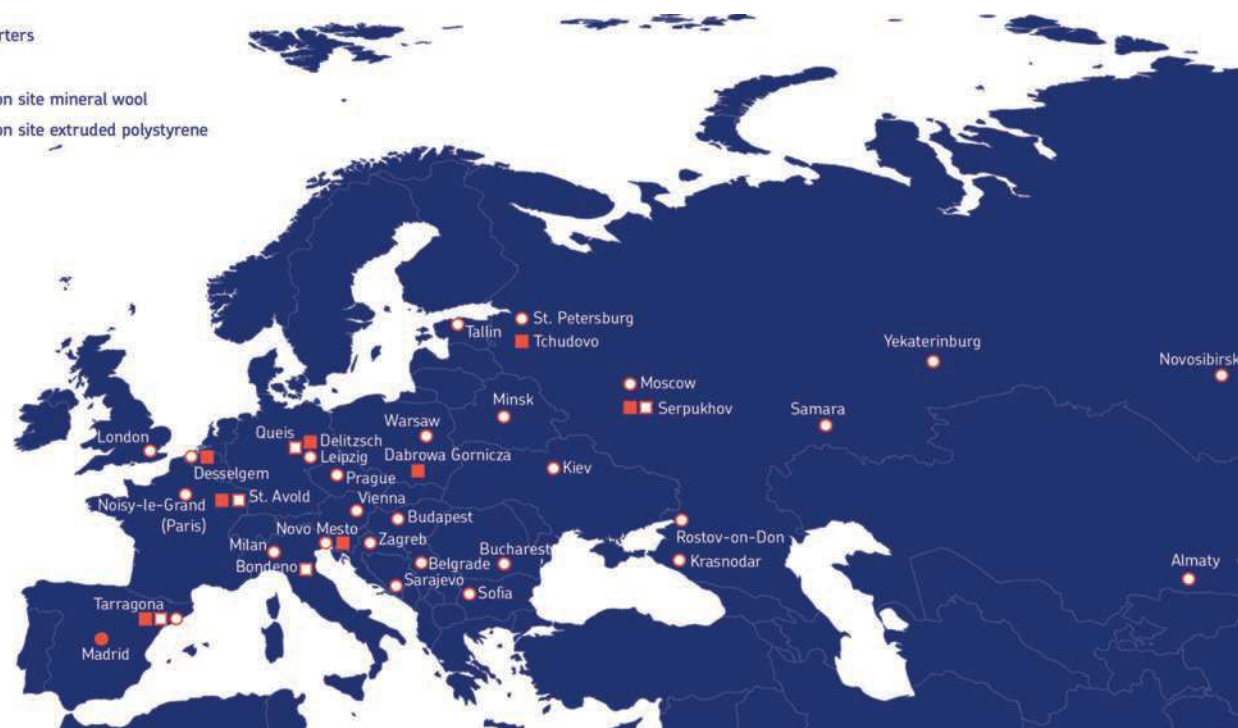

Design

Noise pollution, especially from noisy neighbours or adjacent buildings is a major problem; it is not only of nuisance value but also a major public health issue.

The Building Regulations, Approved Document E and the Building Regulations (Scotland) Technical Book Section 5 therefore seek to impose minimum standards for acoustic insulation depending on whether acoustic protection is required within the building or from external sources.

Sound insulation is required to prevent noise (unwanted sound) being transmitted either from room to room within a building or from external sources. The transmission of noise within a building is by two main routes (see Figure 1):

- Airborne Noise – as the name suggests generally this is noise transmission through the air. It is complicated however in that this noise may generate vibrations in walls, floors, ceilings etc which then transmit the airborne sound to other parts of the building. The use of absorbent layers and/or the addition of mass to the structure will help reduce airborne noise transmission.
- Impact Noise – the most common instance of impact noise is footsteps on floors in blocks of flats and similar buildings. The use of resilient and absorbent layers and/or the addition of mass to the structure will help reduce impact noise transmission.

As well as direct routes for sound transmission buildings are also prone to flanking transmission (See Figure 2) where both airborne and impact sound energy may be transmitted indirectly through the structure (for example at the junctions of floors and walls).

Great care in detailing and the isolation of elements is required to minimise flanking transmission.

Air gaps passing through the structure offer a direct route for sound transmission. Great care should be taken to seal joints between and around elements and around service penetrations.

Glass mineral wool is the ideal material for acoustic insulation as its open, porous structure helps dissipate sound energy whilst denser products can be used as resilient layers in floors.

In summary, the four governing factors of acoustic insulation are:

1. Mass of the element.
2. Structural isolation.
3. Air tightness.
4. Sound absorption characteristics of materials in the construction.

Figure 1 – Sound Transmission

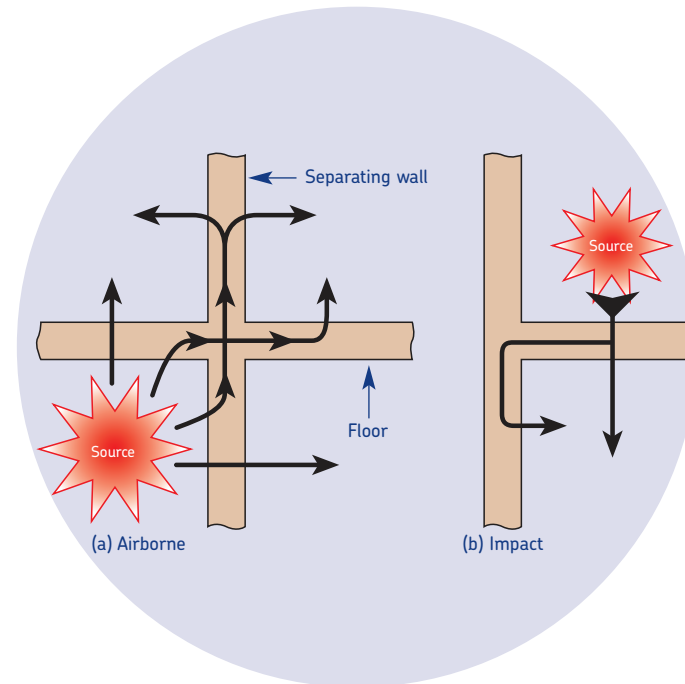
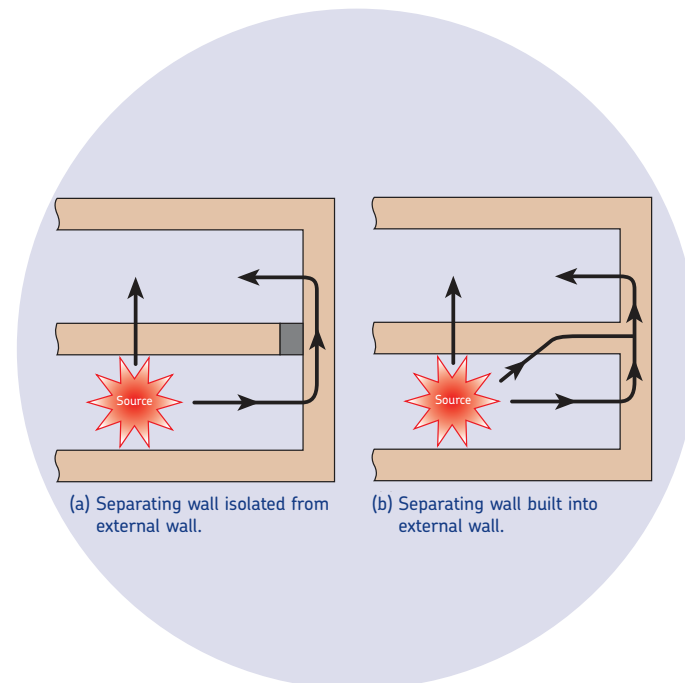

Figure 2 – Flanking Sound Transmission



Acoustics

Acoustic Performance

The sound absorption coefficient, α_s , of 100mm URSA Acoustic Roll measured in accordance with BS EN ISO 354 is as follows:

Sound absorption coefficient

Frequency (Hz)	125	250	500	1000	2000	4000
Sound absorption coefficient (α_s)	0.76	1.06	1.08	1.05	1.08	1.09

Workmanship & Detailing

The acoustic performance of any element depends to a large extent on detailing and workmanship. The following points must always be considered:

- Ensure insulation quilt covers the whole area fitting tightly between the studs without sagging or creating gaps.
- Do not over compress the insulation quilt.
- Ensure cavity closers are flexible and fixed to one frame only.
- Stagger all joints in linings to avoid direct air paths.
- Seal all joints with flexible sealant to avoid air paths.
- Ensure that there are no connections between the two leaves in party walls – if required for structural reasons keep the number to a minimum.
- Avoid electrical sockets and switches on separating walls. If they cannot be avoided stagger their position and use special detailing to maintain acoustic integrity (see Robust Details Part E).
- Fix two or more layers of plasterboard independently.
- When installing 2 or more layers of plasterboard ensure that they are different thicknesses, generally 12.5mm and 19mm, for optimum acoustic performance.

Building Regulation Requirements

Approved Document E is split into 4 sections:

- E1 – Separating (party) walls and floors in dwellings, flats and residential rooms.
- E2 – Internal partition walls and floors in dwellings, flats and residential rooms.
- E3 – Reverberation in common parts of buildings containing flats.
- E4 – Schools.

Approved Document E gives typical construction details that should meet the requirements detailed below.

Pre-completion testing on separating walls and floors is required however with the onus on the builder (as workmanship has a major impact) to demonstrate that the requirements have been met. Failure to comply will result in costly remedial works.

Testing may be avoided by adopting the solutions contained in Robust Details Part E. The Robust Details are based on more stringent requirements than the Building Regulations to give a greater margin for safety and include a site workmanship checklist and a dwelling registration scheme.

Separating (party) walls and floors in dwellings and flats

	Airborne Sound (minimum) ($D_{nT,w} + C_{tr}$ dB)		Impact Sound (maximum) ($L_{nT,w}$ dB)	
	New Build	Change of Use	New Build	Change of Use
Walls	45	43	-	-
Floors & stairs	45	43	62	64

Partition floors and walls in dwellings and flats

	Airborne Sound (minimum) (R_w dB)
Walls	40
Floors	40

Installation

Timber/Steel Frame Partition Walls (See Figure 3)

URSA Acoustic Roll is designed to fit between the studs against the plasterboard lining. This detail complies with Approved Document E.

The usual procedure for construction is:

1. Fit the timber or steel studs in the normal manner and in accordance with the manufacturer's instructions. Seal the studwork system including sole plates and head plates against the surrounding structure with a flexible sealant.
2. Fit 12.5mm plasterboard, either nail or screw fixed, to one side of the partition. The plasterboard must give a minimum mass per unit area of 10 kg/m².
3. Install 25mm (minimum) URSA Acoustic Roll between the studs against the first layer of plasterboard ensuring the entire area is covered. The insulation may be secured to the head plate using a screw fixed timber batten.
4. The other layer of 12.5mm plasterboard (minimum 10 kg/m²) is then fixed.
5. Ensure that all joints around the partition and around service penetrations are sealed using a flexible sealant.

Figure 3 – Timber/Steel Frame Partition Wall

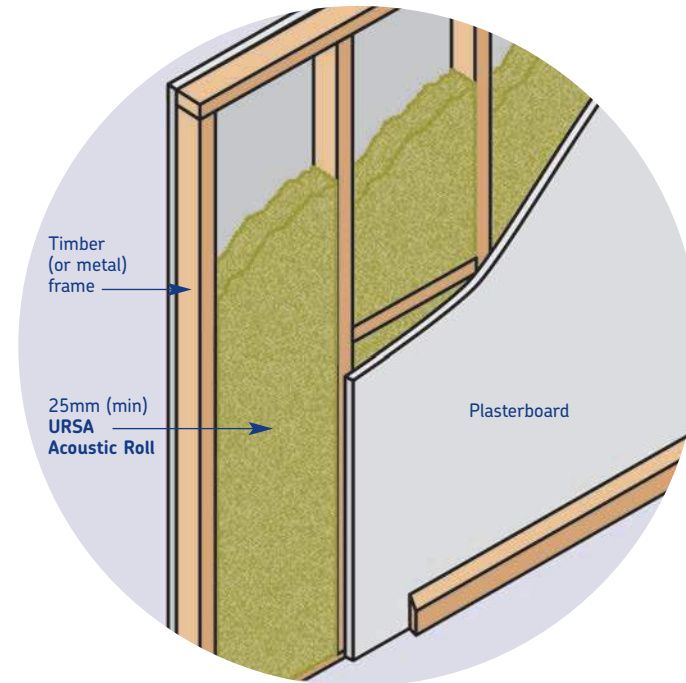

Timber Frame Separating (Party) Walls (see Figures 4 & 5)

URSA TF Roll and URSA Acoustic Roll are designed to fit between the studs in each wall and between each leaf. This detail complies with Robust Details and the MIMA design guide 'Preventing Thermal Bypasses in Party Separating Walls' (these also detail junctions of elements, services etc).

The usual procedure for construction is:

1. Fit the timber frame walls in the normal manner and in accordance with the manufacturer's details ensuring a minimum of 240mm between the inner faces of the wall linings and 50mm separation between the studs in each leaf. If, for structural reasons, a sheathing board is used on one or both leaves ensure a 50mm gap is maintained between the panels.
2. Install URSA TF Roll in each frame fully filling the depth of the studs. Install URSA Acoustic Roll between the frames, with or without plywood sheathing. Account for on-site tolerances and ensure the space is fully filled across the whole wall area.
3. Install vertical cavity barriers to seal the cavity (for acoustic, thermal and fire performance) ensuring that they are contiguous with the party cavity wall insulation.
4. Ensure that all joints around the partition and around service penetrations are sealed using a flexible sealant.

The additional heat loss due to thermal bypass in timber frame party/separating walls must now be accounted for in the overall thermal assessment of the building. Fully filling the interstud and interframe voids with mineral wool along with efficient edge sealing can reduce the effective heat loss to 0.00 W/m²K.

For further information see our brochure 'URSA Party Wall Thermal Bypass Solutions'.

URSA mineral wool products are covered by Robust Details Part E for timber framed walls.

Figure 4 – Timber Frame Separating Wall

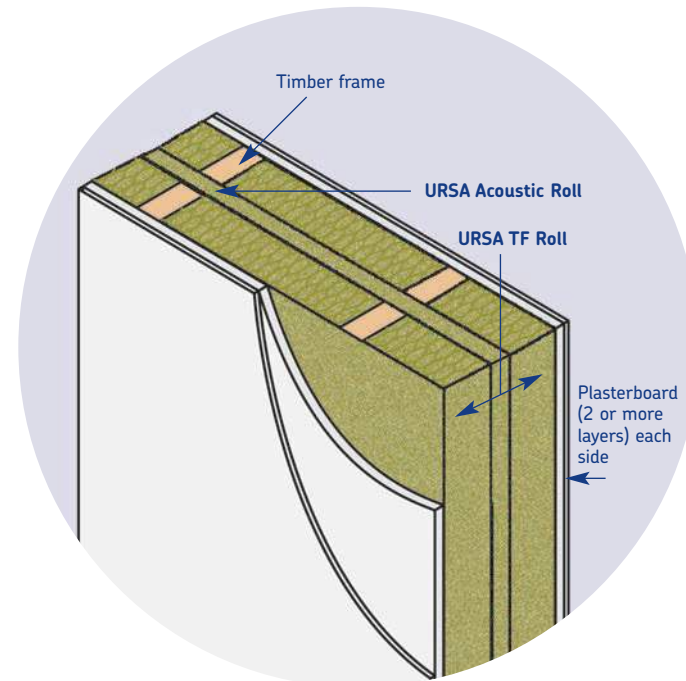

Figure 5 – Timber Frame Separating/External Wall Junction

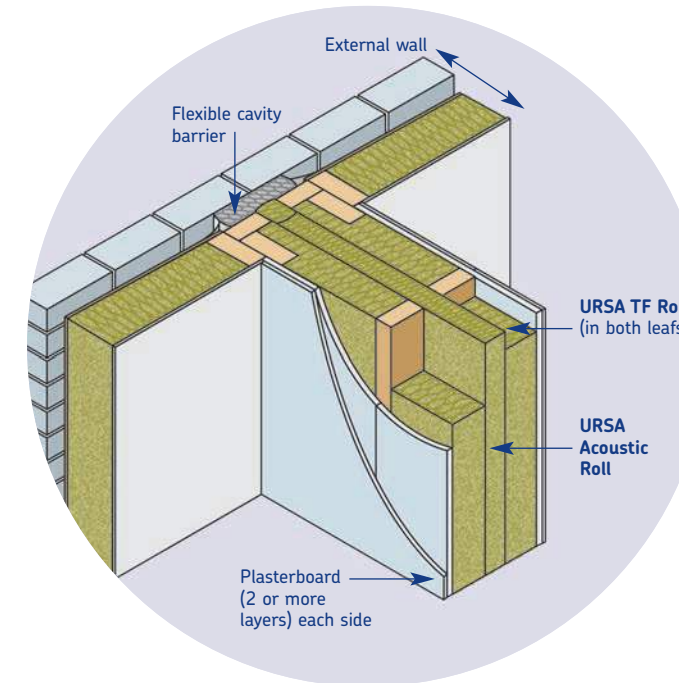
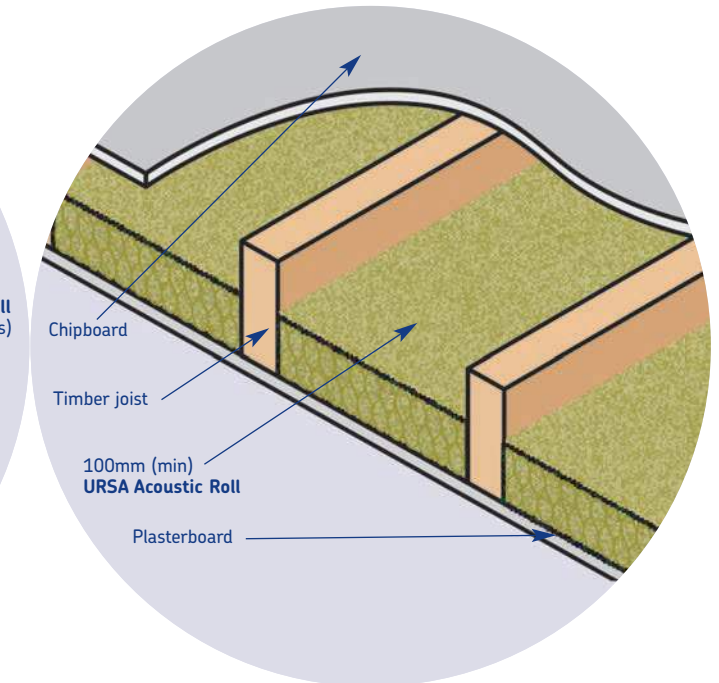

Figure 6 – Internal Timber Floor



Internal Timber Floors (See Figure 6)

URSA Acoustic Roll, minimum 100mm thick, is designed to fit between the floor joists as an absorbent layer. The timber floor finish should have a minimum mass of 15 kg/m² and the plasterboard ceiling should have a minimum mass of 10 kg/m². Insulation against impact noise can be improved by the use of a carpet floor finish.

This detail complies with Approved Document E.

Internal Concrete Beam & Block Floors (See Figure 7)

The beam and block floor system should have a minimum mass of 220 kg/m² and have a minimum 40mm thick bonded screed.

URSA Acoustic Roll, normally either 25mm or 50mm thick to fill the ceiling void, is designed to fit above the plasterboard ceiling as an absorbent layer.

The plasterboard ceiling should have a minimum mass of 10 kg/m² and be installed on resilient channels (see Ceiling Treatment C, Section 3 of Approved Document E). Insulation against impact noise can be improved by the use of a carpet floor finish.

This detail complies with Approved Document E.

Figure 7 – Internal Concrete Floor

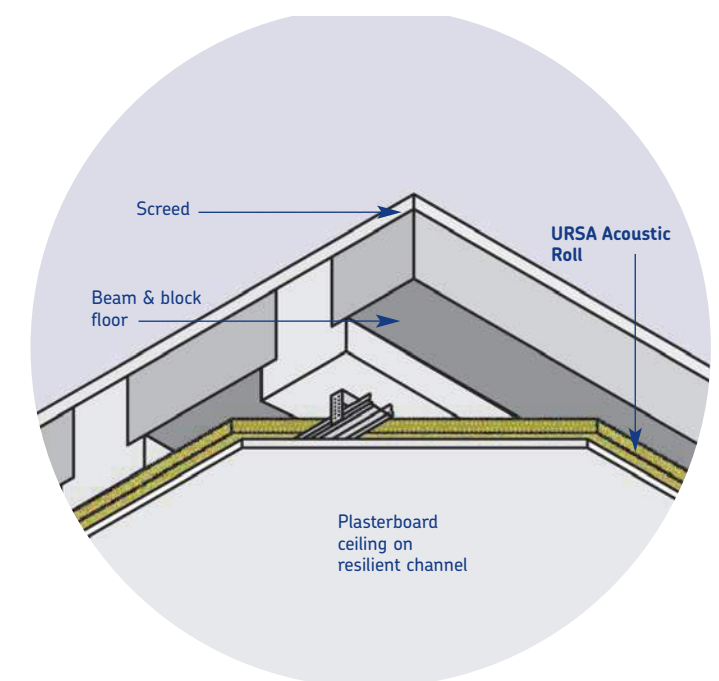

Installation

Timber Separating Floors (See Figures 8 & 9)

For use with timber framed walls only. **URSA Acoustic Roll**, minimum 100mm thick, is designed to fit between the floor joists. **URSA Acoustic Roll**, minimum 25mm thick (for timber I-joists and metal web joists) or minimum 60mm (for solid timber joists) is designed to fit between the battens in the floating floor system.

In conjunction with a resilient batten flooring system and suitable ceiling system this complies with Robust Details Part E (these also detail junctions of elements, services etc).

Figure 8 – Timber Separating Floor (I-joist or metal web joist)

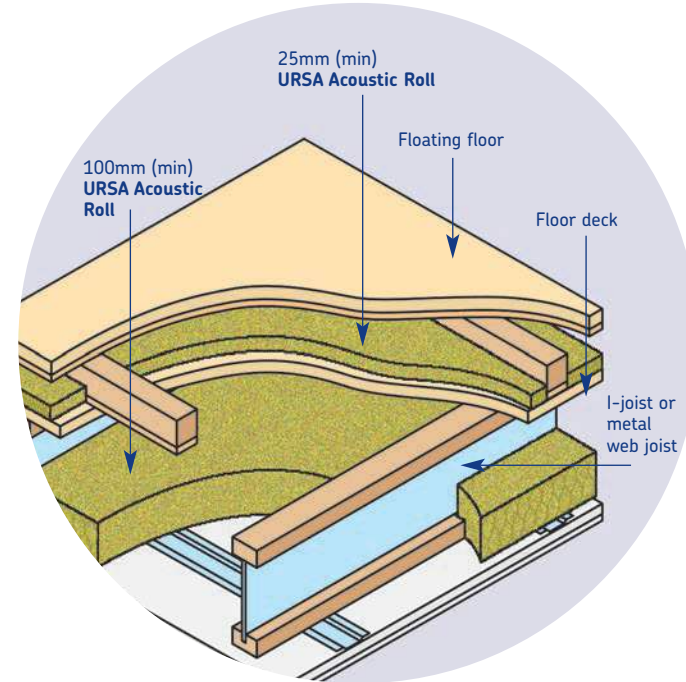
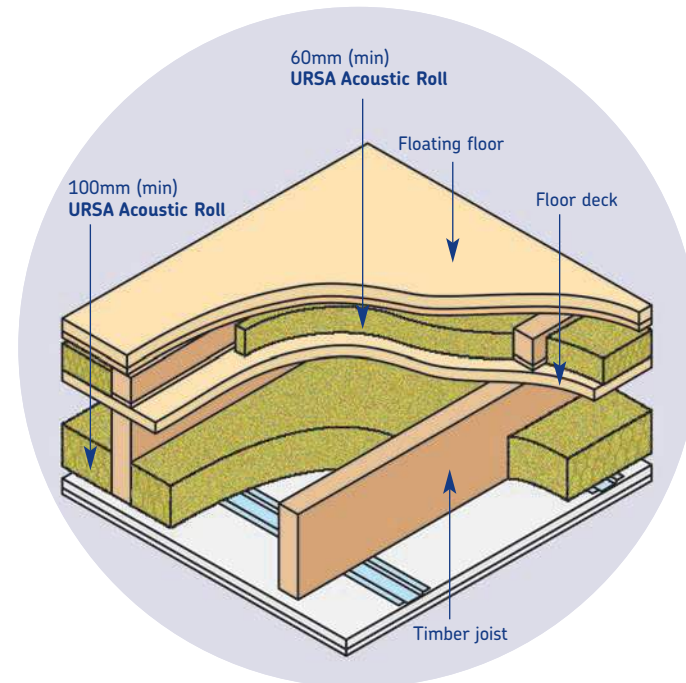

Figure 9 – Timber Separating Floor (solid timber joist)



Pitched Roofs (See Figures 10 & 11)

URSA TF Roll/Slab and **URSA Loft Roll**, minimum 100mm thick, are designed to fit either between the ceiling joists or at rafter level to prevent noise transmission through or over the pitched roof structure. These products comply with the various wall/roof junctions in Robust Details Part E.

URSA Acoustic Roll is suitable for use in a range of floor and wall details in refurbishment and conversion work in dwellings. Section 4 of Approved Document E gives deemed to satisfy constructions for different floor and wall types.

For further information see our brochure 'URSA Party Wall Thermal Bypass Solutions'.

Figure 10 – Roof Junction (separating wall/attic space)

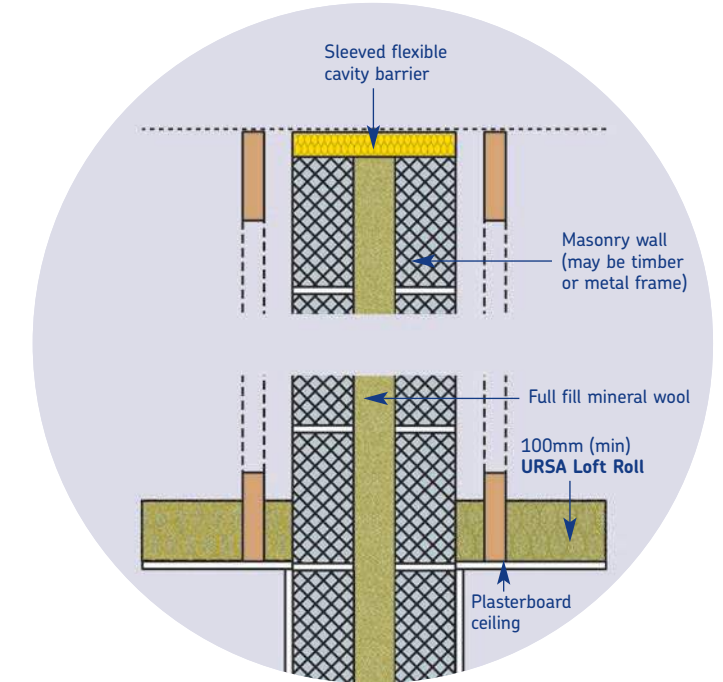
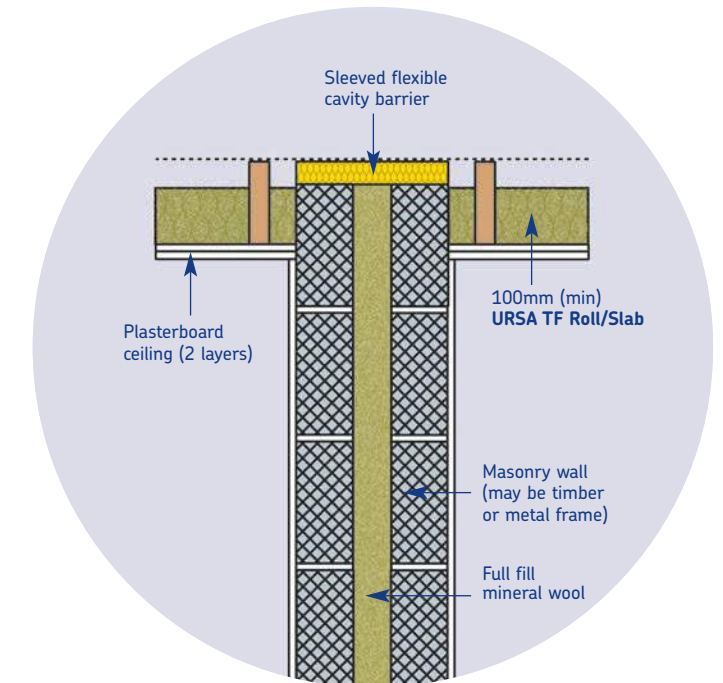

Figure 11 – Roof Junction (separating wall/room in roof)



Specification Clauses

Specification Clause

The following clauses outline the use of **URSA Acoustic Roll** in a range of floor and wall details.

Timber/Metal Frame Partition Walls

The internal partition wall insulation shall be 25mm (minimum) **URSA Acoustic Roll**. The insulation is to be installed as work proceeds in accordance with URSA UK Ltd instructions and the Building Regulations Approved Document E.

Timber Frame Separating (Party) Wall

The separating (party) wall insulation shall be **URSA TF Roll** installed in both frames fully filling the depth of the studs. Install additional **URSA Acoustic Roll** between the frames to fully fill the void. Account for on-site tolerances and ensure the space is fully filled across the whole wall area. The insulation is to be installed as work proceeds in accordance with URSA UK Ltd instructions, the Building Regulations Approved Document E and Robust Details Part E.

Internal Timber Floors

The floor joist insulation shall be 100mm (minimum) **URSA Acoustic Roll**. The insulation is to be installed as work proceeds in accordance with URSA UK Ltd instructions and the Building Regulations Approved Document E.

Internal Concrete Floors

The ceiling void shall be fully filled with **URSA Acoustic Roll**. The insulation is to be installed as work proceeds in accordance with URSA UK Ltd instructions and the Building Regulations Approved Document E.

Timber Separating Floors

The separating floor joist insulation shall be 100mm (minimum) **URSA Acoustic Roll**. **URSA Acoustic Roll**, minimum 25mm thick (for timber I-joists and metal web joists) or minimum 60mm (for timber joists) shall be used between the battens in the floating floor system.

The insulation is to be installed as work proceeds in accordance with URSA UK Ltd instructions, the Building Regulations Approved Document E and Robust Details Part E.



Technical Details

Thermal Conductivity

The declared thermal conductivity of **URSA Acoustic Roll** is 0.035 W/mK when tested to BS EN 13162.

Density

Nominal density is 22 kg/m³ (25, 50, 60, 75 & 140mm). Minimum density is 12 kg/m³ (100mm).

Reaction to Fire

Euroclass A1 to BS EN 13501-1.

Moisture Vapour Transmission

URSA Acoustic Roll has minimal resistance to the passage of water vapour, thus allowing the floor or wall construction to breathe. A practical value for the moisture vapour resistivity is 5 MNs/gm.

Specific Heat Capacity

The specific heat capacity of **URSA Acoustic Roll** is 0.84 kJ/kgK.

Designation Code

MW – EN 13162 – T2 – DS(70,-) – MU1 – AFR5.

URSA Acoustic Roll

Dimensions		
Thickness (mm)	Length (m)	Width (mm)
25	20.00	2 x 600
25	20.00	1200
50	12.00	2 x 600
60	10.00	2 x 600
75	8.00	2 x 600
100	6.00	2 x 600
140	4.25	2 x 600

Acoustic Performance

The sound absorption coefficient, α_s , of 100mm **URSA Acoustic Roll** measured in accordance with BS EN ISO 354 is as follows:

Sound absorption coefficient

Frequency (Hz)	125	250	500	1000	2000	4000
Sound absorption coefficient (α_s)	0.76	1.06	1.08	1.05	1.08	1.09

Environmental Information

BRE Green Guide

All URSA mineral wool products achieve the best possible 'A+' rating under the BRE Green Guide.

Manufactured to BS EN ISO 14001.

Durability

When correctly installed, URSA mineral wool products are maintenance free and have an indefinite life at least equal to that of the building.

Storage

URSA mineral wool products are supplied wrapped in polythene to provide short-term protection. On site the rolls should be stored clear of the ground, on a clean level surface and under cover to protect them from prolonged exposure to moisture or mechanical damage.

Chemical Compatibility

URSA mineral wool products are compatible with all common construction materials, alkalis, dilute acids, mineral oil and petrol. Products that have been in contact with harsh solvents, acids or saturated with water should not be used.

Health and Safety

URSA mineral wool products are inherently safe to handle. During cutting or handling any dust generated is of nuisance value only; the wearing of dust masks, gloves and long sleeved clothing is recommended. Large scale machining should be connected to a dust extraction system.

A comprehensive Health and Safety data sheet is available from URSA UK Ltd upon request.

Availability

URSA Acoustic Roll is available nationally through insulation distributors and builders merchants.

References

- The Building Regulations and supporting documents.
- Preventing Thermal Bypasses in Party Separating Walls (MIMA – Mineral Wool Insulation Manufacturers Association).
- Robust Details Part E (Robust Details Ltd).
- BS 8233 Code of Practice for Sound Insulation and Noise Reduction for Buildings.
- BS EN 12354 Building Acoustics – Estimation of Acoustic Performance of Buildings from the Performance of Elements.
- BS EN ISO 140 Acoustics – Measurement of Sound Insulation in Buildings and of Building Elements.
- BS EN ISO 717 Acoustics – Rating of Sound Insulation in Buildings and of Building Elements.
- BRE Digests, Information Papers and Good Building Guides.